

DRW No. :-

IF ANY DOUBT ASK.

THE INFORMATION CONTAINED IN THIS DRAWING IS THE ONLY PROPERTY OF SHARP ENGINEERS ANY REPRODUCTION IN PART OR AS WHOLE WITHOUT THE WRITTEN PERMISSION OF SHARP ENGINEERS IS PROHIBITED.

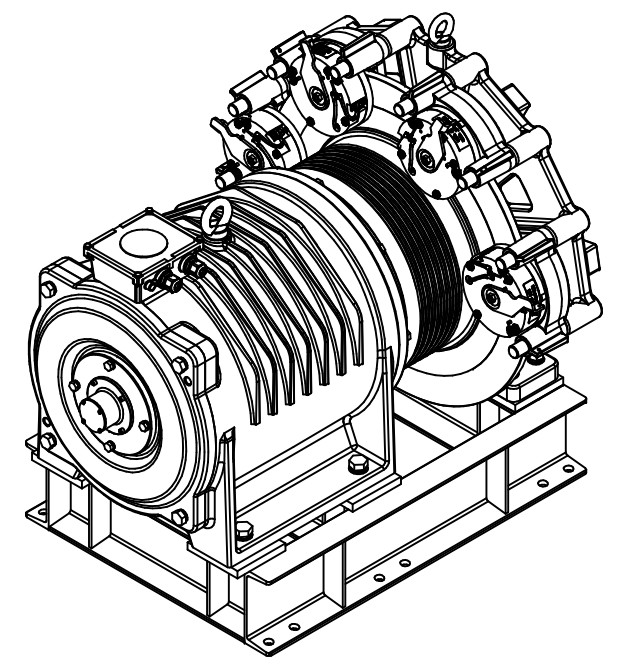
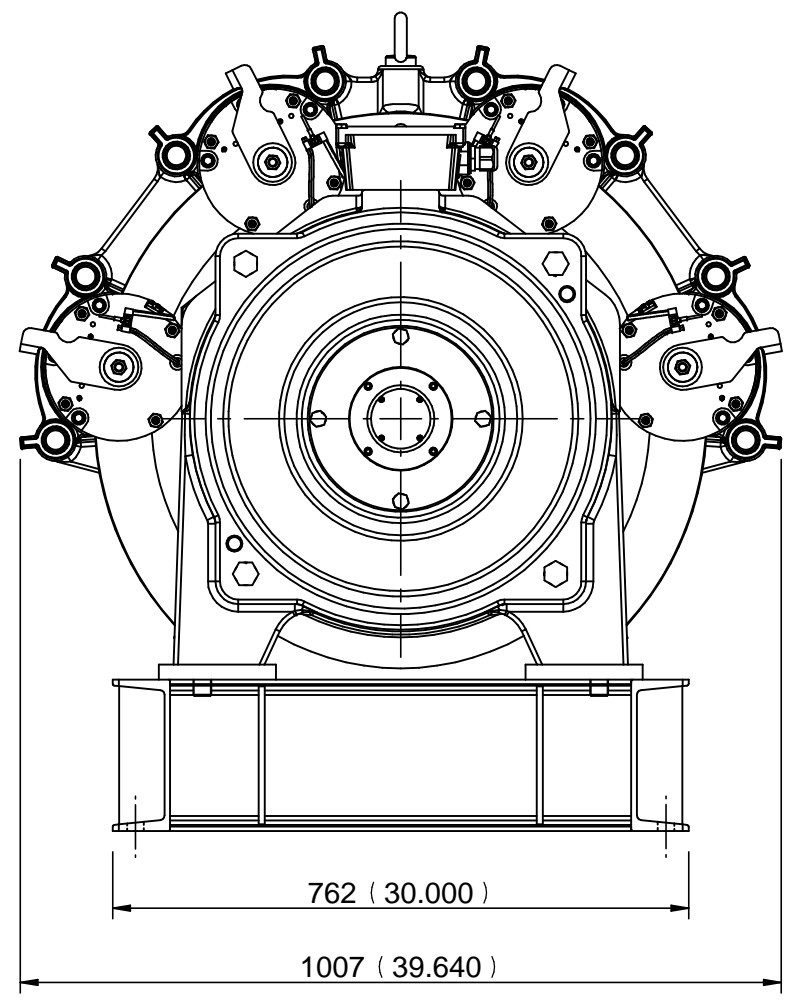
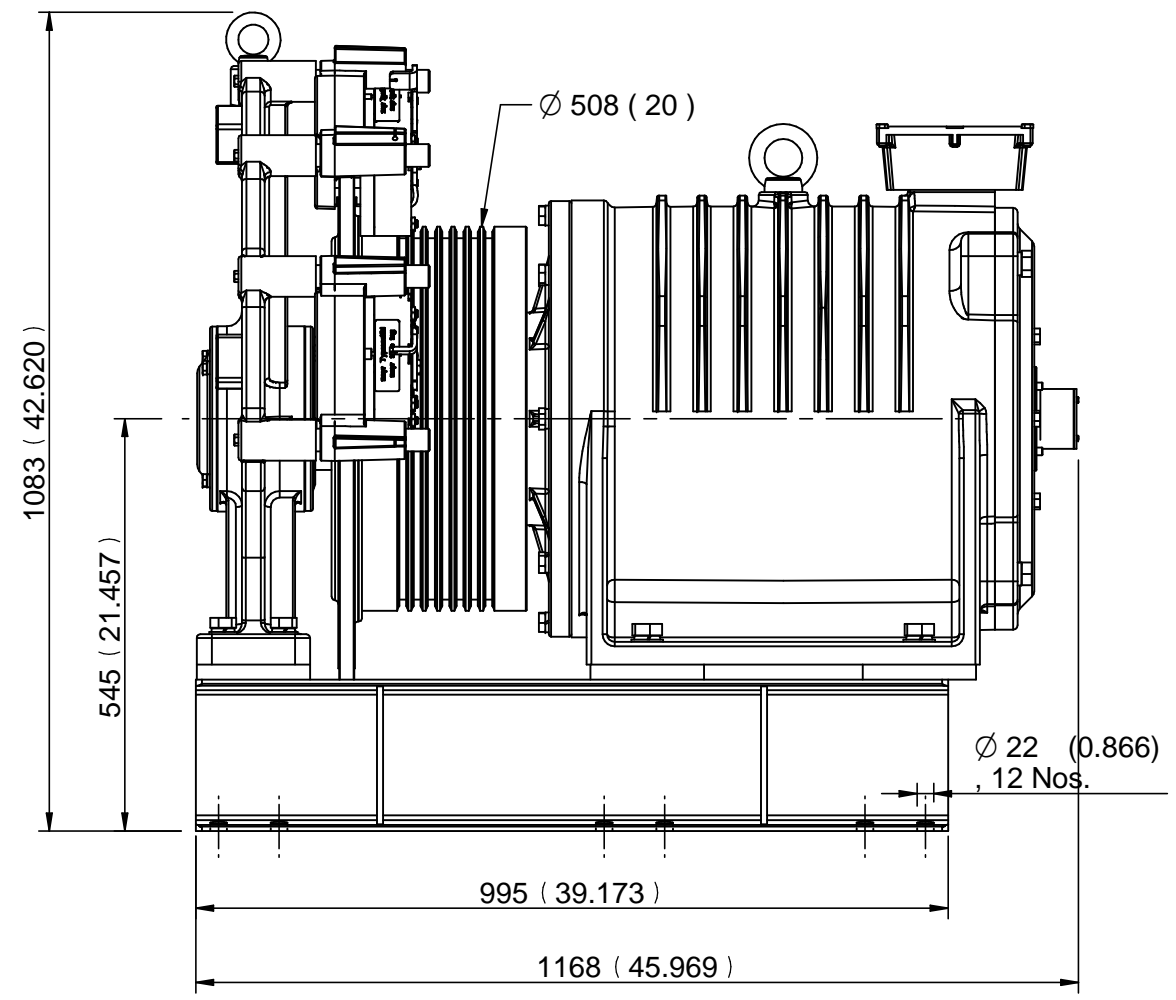

ALL DIMENSIONS ARE IN MM (INCH).

ALLOWABLE DEVIATION FOR UNSPECIFIED DIMENSION (IS 2102 - 1969)										
DEVIATION ± FOR DIMENSIONS					ALL DIMENSIONS ARE IN MM					
OVER	0.5	3	6	30	120	315	1000	2000	4000	
UPTO	3	6	30	120	315	1000	2000	4000	8000	
LENGTH	0.1	0.1	0.2	0.3	0.5	0.8	1.2	2	3	
RADII,CHF	0.2	0.5	1	2	4	-	-	-	-	

SURFACE PROTECTION				MATERIAL	AS PER BOM
MECH. CHARACT				R.MAT SIZE	AS PER DRW
HEAT TREATMENT		--			
SURFACE TREATMENT		--			
DEGREE OF FINISH		CASTING WEIGHT	Kg	TITLE:- GA DRW SEG-X7 LONG WRAP MACHINE 3500 lbs	
▽ - 12.5 TO 25		MACHINED WEIGHT	Kg		
▽▽ - 1.5 TO 3		QUANTITY	01 No.		
G - 0.2 TO 0.8		SCALE	1:1		
▽▽▽ - 0.025 TO 0.5		DRWN BY	ANKIT PATEL	25/11/2024	DRW No. :-
SF - SPOTFACE		APPRVD BY	ANKIT PATEL	25/11/2024	

REVISION No.	DESCRIPTION	DATE	APPROVED BY